

Maestro

DESIGN: GIANPAOLO PRADAL



Loran
everyday passion



Maestro

La nuova linea di arredamenti per laboratori odontotecnici Maestro, unisce un nuovo e moderno design alla funzionalità e alla resistenza dei materiali quali l'acciaio elettrozincato e verniciato, i piani in inox, il legno. Una gamma completa di banchi, mobili modulari, cappe e accessori consente di personalizzare ogni zona operativa.

The new line of furniture for dental laboratories Maestro, combines innovative modern design with functionality and the resistance of materials such as galvanized and painted steel, stainless steel worktops and wood. A complete range of benches, service cabinets, suction hoods and accessories allows you to customize each operation area.

La nouvelle gamme de meubles Maestro, pour laboratoires de prothèse, combine un design nouveau et moderne avec la fonctionnalité et la résistance des matériaux tels que l'acier galvanisé et peint, les plans en acier inox, le bois. Une gamme complète d'établis, de modules, des hottes et accessoires vous permet de personnaliser chaque zone d'opération.

Die neue Möbellinie Maestro für das zahntechnische Labor kombiniert innovatives modernes Design mit Funktionalität und widerstandsfähigen Materialien wie verzinktem und lackiertem Stahl, Edelstahl-Arbeitsplatten oder Holz. Eine komplette Linie von Arbeitstischen, Beistellmöbeln, Abzugsschränken und Zubehör erlaubt eine individuelle Anpassung an alle räumlichen Gegebenheiten.

La nueva línea de mobiliario para laboratorios dentales, combina un nuevo diseño moderno, funcional, fabricado con materiales muy resistentes como el acero electro-galvanizado y pintado, encimeras de acero inoxidable o de madera. Una gama completa de mesas, muebles modulares, campanas y accesorios permite personalizar cualquier área de trabajo.





I banchi possono essere a una o due postazioni, forniti con o senza schiena, su richiesta.

The workbenches are available with one or two workstations, and, upon request, with or without backside panel.

Les établis peuvent être à un ou deux postes fournis, sur demande, avec ou sans dossier.

Die Arbeitstische sind in Versionen mit einem oder zwei Arbeitsplätzen, mit oder ohne Rückwand erhältlich.

Las mesas pueden ser de uno o dos puestos, suministrados con o sin trasera.



I banchi Maestro sono predisposti per l'inserimento del funzionale impianto di aspirazione.

The Maestro workbenches are prepared to be equipped with an aspiration system.

Les établis Maestro peuvent accueillir le système fonctionnel d'aspiration.

Die Arbeitsplätze sind konzipiert zur Aufnahme verschiedener Absaugsysteme.

Las mesas Maestro tienen instalado el sistema de aspiración, sólo pendiente de conectar el aspirador deseado.



Le varie configurazioni permettono di creare la soluzione più adatta a soddisfare le esigenze del laboratorio.

The various configurations allow to create the best solution to meet the specific needs of the laboratory.

Les différentes configurations permettent de créer la meilleure solution pour répondre aux besoins du laboratoire.

Die verschiedenen Konfigurationen erlauben eine individuelle Anpassung an die räumlichen Gegebenheiten des Labors.

Las distintas configuraciones permiten crear la solución más adecuada para satisfacer las exigencias del laboratorio.





Utili accessori completano le postazioni di lavoro come, ad esempio, le lampade, la protezione in inox della zona di lavoro e le bacinelle sospese su un essenziale supporto in acciaio verniciato.

The workstations can be equipped with various useful accessories such as, for example, lamps, stainless steel protective covers for the worktop and work piece basins suspended on a painted steel support.

Les postes de travail peuvent être complétés par des accessoires utiles, comme par exemple: lampes, protection en acier du poste

de travail, bassinets porte-travail suspendues sur un essentiel support en acier verni.

Die Arbeitsplätze können auf Wunsch mit verschiedenem nützlichem Zubehör ausgestattet werden, z.B.: Leuchten, Edelstahl-Schutzabdeckungen der Arbeitsplatte, oder Arbeitsschalen mit entsprechender Aufhängevorrichtung aus lackiertem Stahl.

Unos accesorios útiles equipan los puestos de trabajo como, por ejemplo, las lámparas, la protección de acero inoxidable del área de trabajo y las bandejas que cuelgan de un indispensable soporte de acero pintado.





Il banco ad angolo raggruppa le due diverse zone operative con un pratico alloggiamento per il forno e i relativi accessori.

The corner bench brings the two different work areas together and provides the technician with a practical storage site for the oven and related accessories.

L'établi d'angle réuni les deux postes de travail avec la place pour les accessoires et le four.

Der Ecktisch bietet zwei Arbeitsplätze, und dazu noch Platz für Zubehör und einen Keramikofen.

La mesa en ángulo reúne las dos distintas zonas de trabajo con un cómodo alojamiento para el horno de cerámica y sus accesorios.





I mobili di servizio sono dotati di un'ampia modularità con il preciso obiettivo di ottenere il massimo livello di funzionalità dell'ambiente di lavoro. La serie "S" poggia su supporto aperto con piedini.

Having the precise aim of assuring the greatest possible functional efficiency in every specific work area, these service cabinets are equipped with an extensive modular set-up. The "S" Series stand on open feet.

Les modules sont équipés avec une grande modularité dans le but précis d'atteindre le plus haut niveau de fonctionnalité dans le lieu

de travail. La série "S" est sur pieds.

Die Beistellmodule sind modular konzipiert, und können sich daher individuell allen räumlichen Gegebenheiten anpassen; Die S-Serie ist auf Füßen konzipiert.

El sistema modular de los muebles consigue el objetivo preciso de obtener el máximo nivel de funcionalidad en el área de trabajo. La serie "S" se apoya sobre una base abierta con patas.



MOBILI FURNITURE - MODULES - SCHRÄNKE - MUEBLES

CAPPE SUCTION HOODS - HOTTES ASPIRANTES
OFENSCHRÄNKE - CAMPANAS ASPIRANTES

"B"



Le cappe sono composte da una base, un piano in acciaio inox ed una parte superiore chiusa da vetro temperato scorrevole. I mobili della serie "B" poggiano su basamento chiuso.

The hoods are made up of a base, an stainless steel surface and an upper part closed by tempered sliding glass. The units of the series "B" stand on closed bases.

Les hottes aspirantes sont composées d'une base, un dessus en acier inox et une partie supérieure fermée par un verre trempé coulissant. La série "B" est sur base fermée.

Die Absaug-Schränke: Unterschrank und Aufsatz sind aus verzinktem Stahl, und der obere Teil wird durch eine verschiebbare Sicherheitsglasplatte verschlossen. Die B-Serie ist auf einem Sockel konzipiert.

Las campanas están constituidas por un mueble bajo, una encimera de acero inoxidable y una parte superior cerrada por un cristal templado corredero. Los muebles de la serie "B" se apoyan sobre una base cerrada.

CAPPE PENSILI

SUSPENDED SUCTION HOODS - HOTTES ASPIRANTES MURAUX
WAND-OFENSCHRÄNKE - CAMPANAS ASPIRANTES COLGANTES

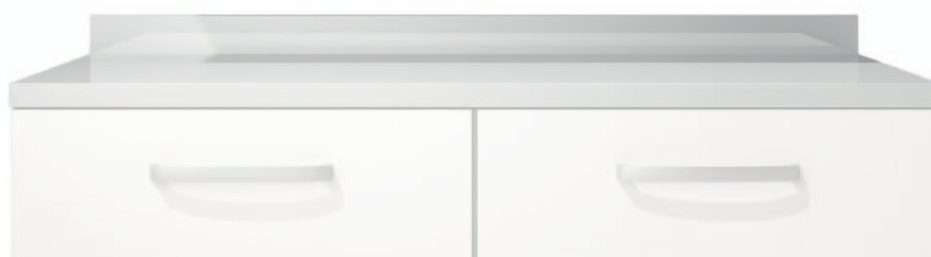

Disponibili anche cappe pensili in acciaio inox, complete di impianto di illuminazione. Permettono ampia libertà di movimento nella zona sottostante.

Available also suspended stainless steel hoods complete with illumination. These offer greater freedom of movement in the area below.

Egalement disponibles hottes murales en acier inox, avec éclairage, pour la liberté de mouvement dans la zone d'opération.

Die Linie beinhaltet auch wandbefestigte Absaugvorrichtungen mit integrierter Beleuchtung, um ggf. mehr Bewegungsfreiheit in den Arbeitszonen zu schaffen.

Están disponibles incluso campanas colgantes de acero inoxidable, equipadas con instalación de iluminación. Las mismas permiten una amplia libertad de movimiento en el área subyacente.

COLORI

COLOURS - COLORIS - FARBEN - COLORES

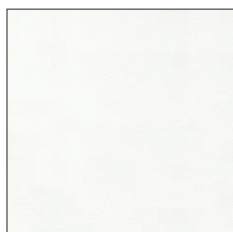

RAL 9010 goffrato

COLORE STRUTTURA - COLOUR STRUCTURE - COLOR STRUCTURE - FARBE KORPUS - COLOR ESTRUCTURA

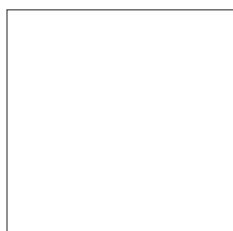

BIANCO Loran



RAL 2001



RAL 5002



RAL 6019



RAL 7045

COLORE FRONTALI - COLOUR FRONTS - COLOR FACADES - FARBE FRONTEN - COLOR FRENTE



BIANCO opaco

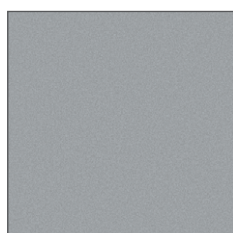

RAL 9006

COLORE MANIGLIE - COLOUR HANDLES - COLOR POIGNÉES - FARBE GRIFFEN - COLOR TIRADORES

Questo campionario colori deve essere considerato solo come guida indicativa del colore e non può essere utilizzato come riferimento originale per la produzione e la valutazione di superfici colorate.

This color sample should be considered only as an indicative guide for color and cannot be used as an original reference for the production and assessment of colored surfaces.

Ce nuancier ne sert qu'à donner une idée des différents coloris et ne doit en aucun cas être utilisé comme référence originale pour la production et l'évaluation des surfaces colorées.

Diese Farbmuster sind unverbindlich und können vom Originalfarbton der hergestellten Oberflächen abweichen.

Esta muestra de colores debe considerarse sólo como una guía indicativa del color, y no puede utilizarse como referencia original para la producción y evaluación de las superficies pintadas.

VERSIONI DESIGN - DESIGN - DESIGN - MODELO

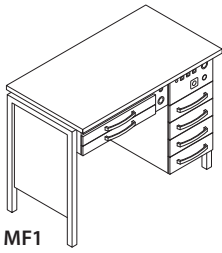

MF1
L=1170
P=640
H=900

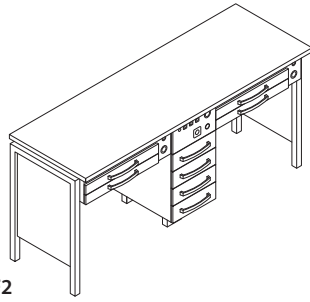

MF2
L=1900
P=640
H=900

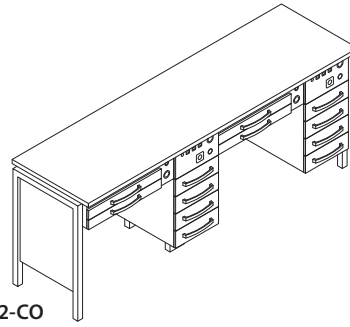

MF2-CO
L=2260
P=640
H=900

BANCHI - BENCHES - ETABLIS - ARBEITSTISCHE - MESAS

"F"

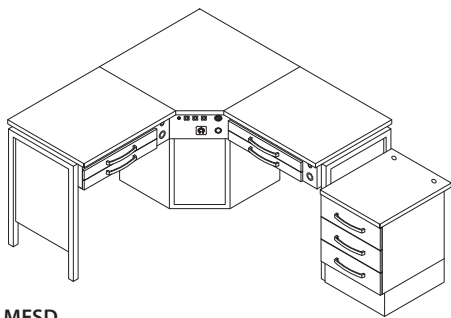

MFSD
L= 2111
P= 1611
H=900

BANCHI - BENCHES - ETABLIS - ARBEITSTISCHE - MESAS

"FSD"

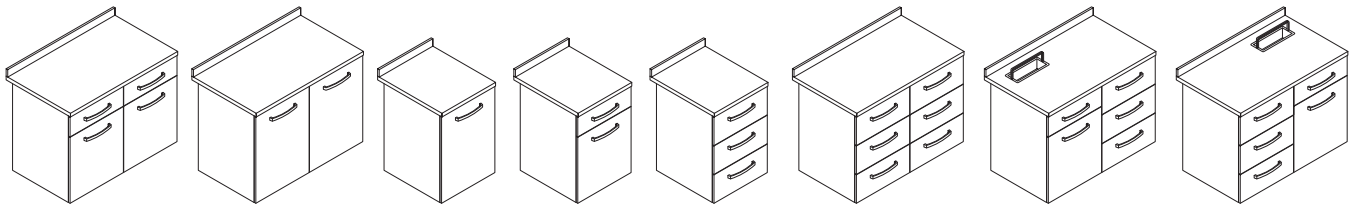

M1
L=1000
P=600
H=730

M2
L=1000
P=600
H=730

M3
L=500
P=600
H=730

M4
L=500
P=600
H=730

M5
L=500
P=600
H=730

M6
L=1000
P=600
H=730

M10
L=1000
P=600
H=730

M11
L=1000
P=600
H=730

MOBILI - FURNITURE - MODULES - SCHRÄNKE - MUEBLES

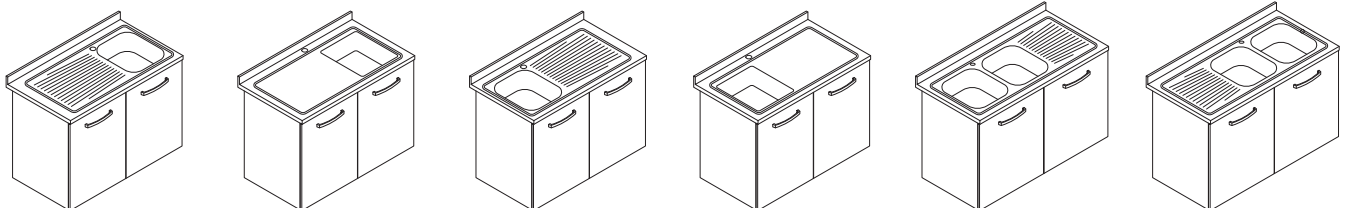

M14
L=1050
P=600
H=730

M14/I
L=1050
P=600
H=730

M15
L=1050
P=600
H=730

M15/I
L=1050
P=600
H=730

M16
L=1200
P=600
H=730

M17
L=1200
P=600
H=730

MOBILI - FURNITURE - MODULES - SCHRÄNKE - MUEBLES

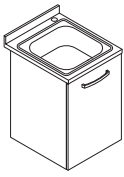

M20
L=500
P=600
H=730

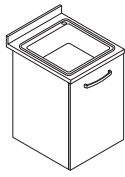

M20/I
L=500
P=600
H=730

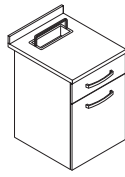

M22
L=500
P=600
H=730

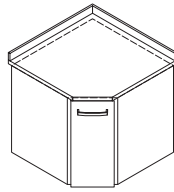

MA
L=785
P=785
H=730

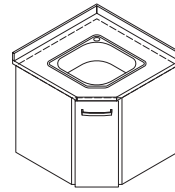

MAL
L=785
P=785
H=730

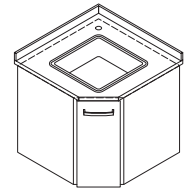

MAL/I
L=785
P=785
H=730

MOBILI - FURNITURE - MODULES - SCHRÄNKE - MUEBLES

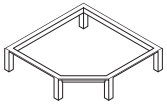

MSA*
L=735
P=735
H=170

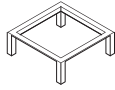

MS050
L=500
P=500
H=170

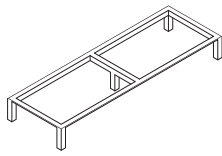

MS100
L=1000
P=500
H=170

MS105
L=1050
P=500
H=170

MS120
L=1200
P=500
H=170

MS150
L=1500
P=500
H=170

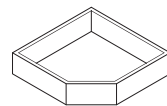

MBA***
L=735
P=735
H=170

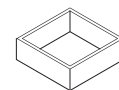

MB01
L=500
P=500
H=170

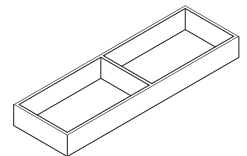

MB02
L=1000
P=500
H=170

MB03
L=1050
P=500
H=170

MB04
L=1200
P=500
H=170

MB05
L=1600
P=500
H=170

SUPPORTI - SUPPORTS - SUPPORT - GESTELLEN - SOPORTE BASAMENTI - BASES - BASES - SOCKEL - BASES

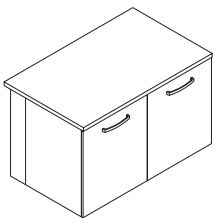

MB120
L=1200
P=740
H=730

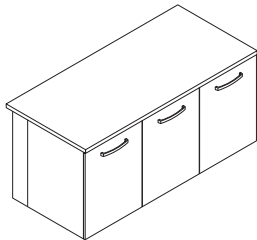

MB160
L=1600
P=740
H=730

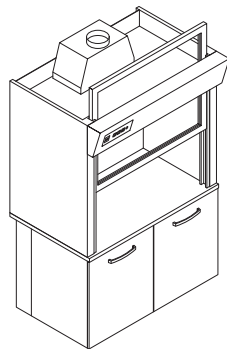

MC120
L=1200
P=740/840
H=1954

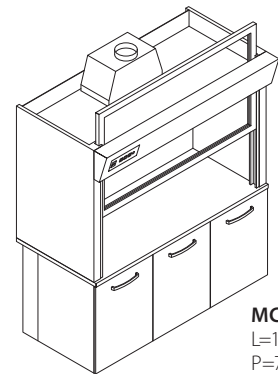

MC160
L=1600
P=740/840
H=1954

CAPPE ASPIRANTI - SUCTION HOODS - HOTTES ASPIRANTES - OFENSCHRÄNKE - CAMPANAS ASPIRANTES

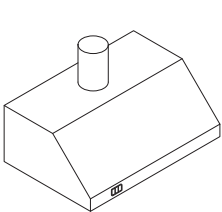

CAP120
L=1200
P=800
H=450

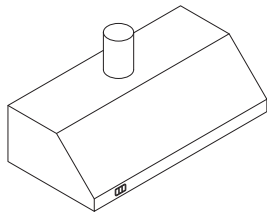

CAP160
L=1600
P=800
H=450

*** Supporto angolare con piedini**
Corner support with feet Support d'angle avec pieds
Eckgestell mit Füßen Soporte angular con patas

**** Supporto con piedini per sottocappa**
Support with feet for hood base
Support avec pieds pour hotte
Gestell mit Füßen für Ofenschränk
Soporte con patas para campana

***** Basamento angolare**
Corner base unit Base d'angle
Ecksockel Base Angular

CAPPE ASPIRANTI - SUCTION HOODS - HOTTES ASPIRANTES - OFENSCHRÄNKE - CAMPANAS ASPIRANTES

Loran
everyday passion



LORAN srl • Via della Lira, 397 zona ind. • 31053 Pieve di Soligo • TV • Italy
Tel. +39 0438 842603 • Fax +39 0438 980233 • loran@loran.it • www.loran.it